

EMBASE OVALE À TOURILLON Ø 15MM

VOLPATO

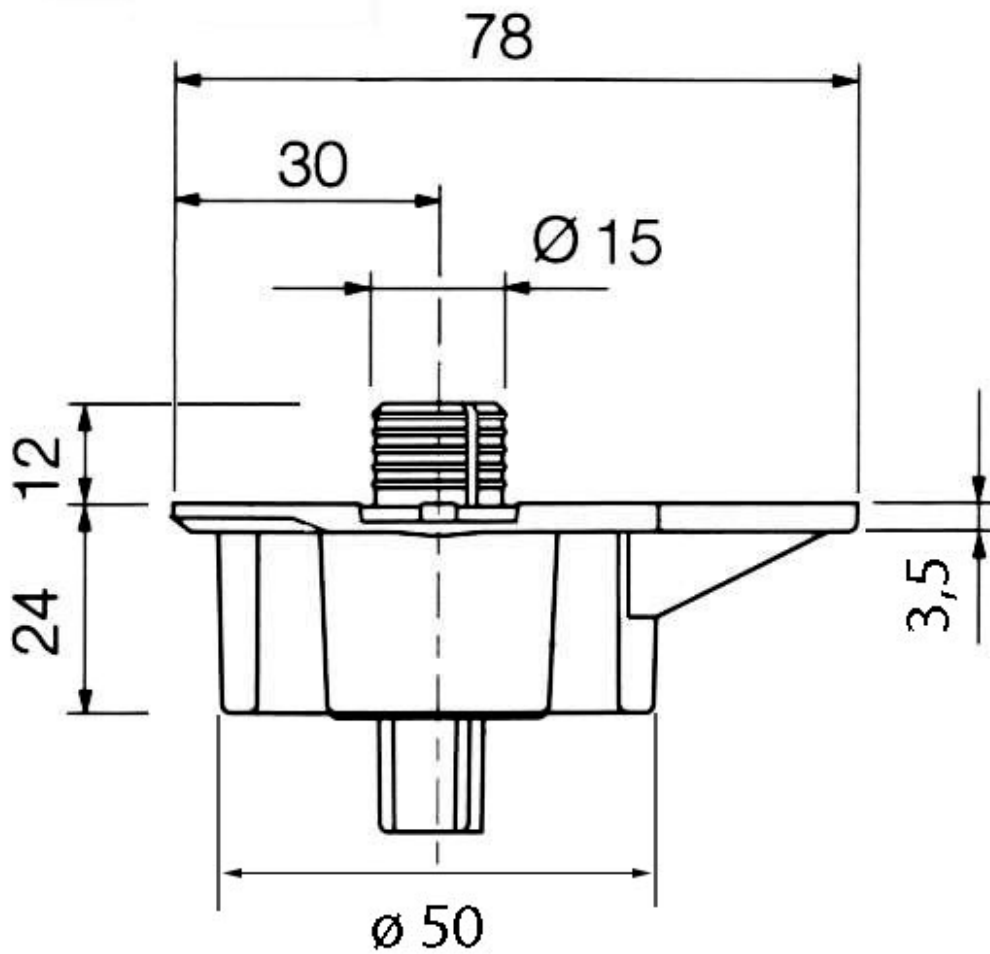

<https://www.qama.fr/embase-ovale-a-tourillon-diam15-p726>



Tel : 02 43 13 49 49

Fax : 02 43 30 26 16

www.qama.fr