

FERMETURE À LEVIER

ITAR

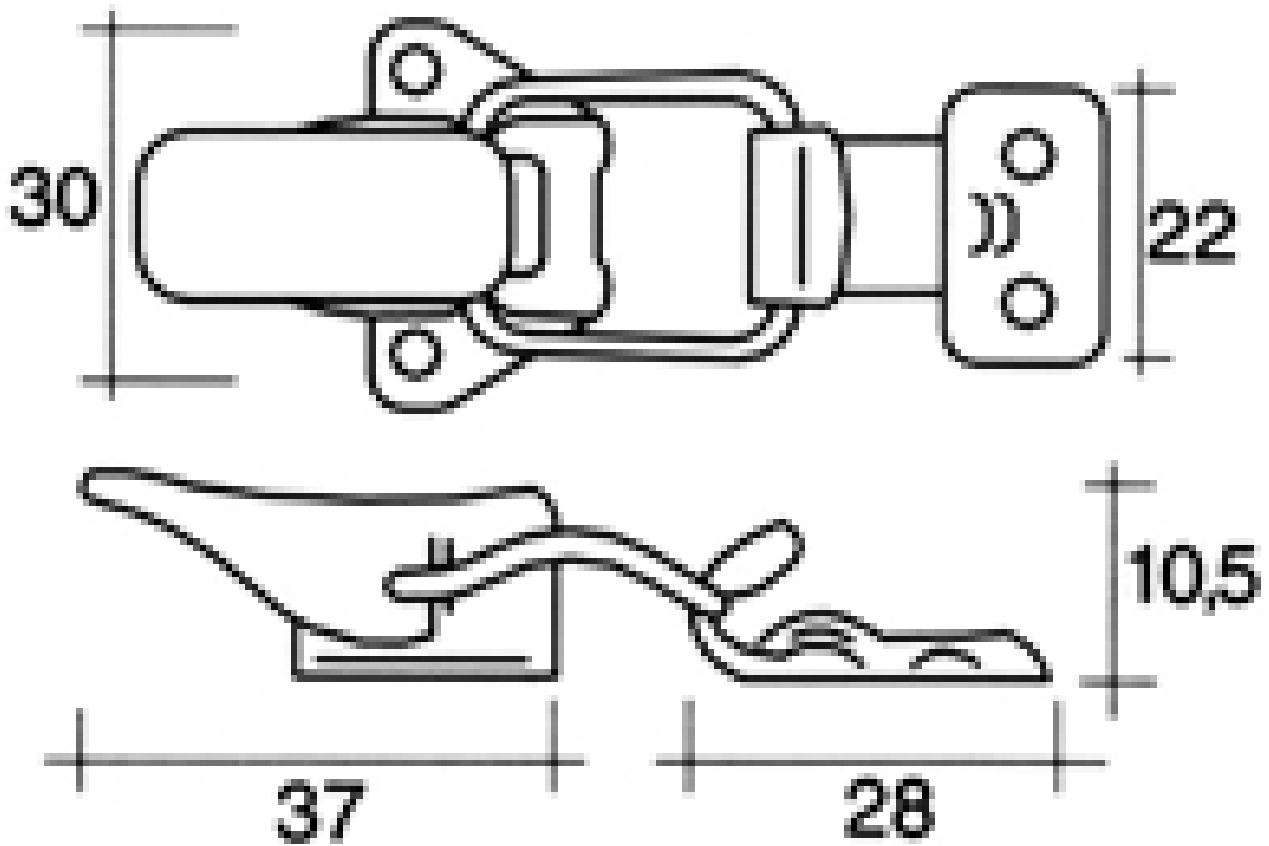

<https://www.qama.fr/fermeture-a-levier-p2505>



Tel : 02 43 13 49 49

Fax : 02 43 30 26 16

www.qama.fr