

PORTE ROULEAU PAPIER TOILETTE

ITAR

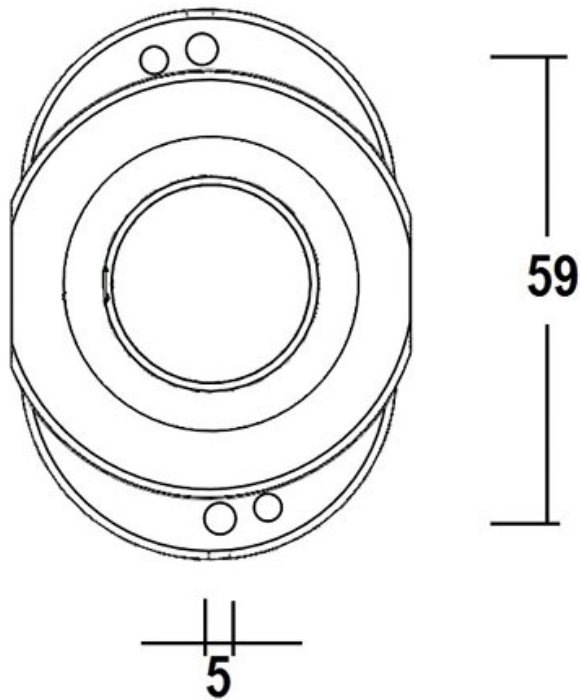

<https://www.qama.fr/porte-rouleau-papier-toilette-p59299>



Tel : 02 43 13 49 49

Fax : 02 43 30 26 16

www.qama.fr